

Charko®

PUMP

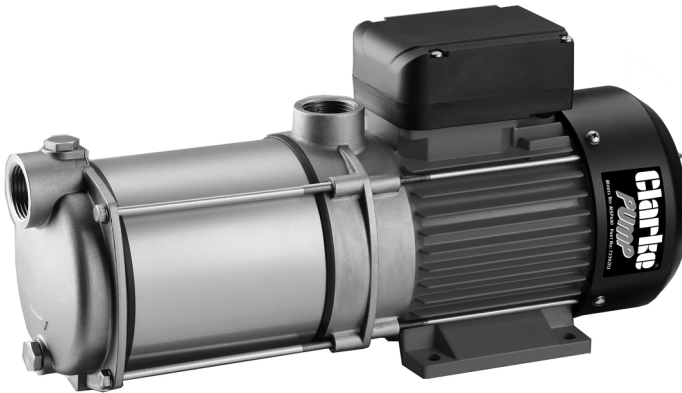

MULTI-STAGE BOOSTER PUMPS MODEL NO: MSP490, 590 & 690

PART NO: 7239202, 7239203 & 7239204

OPERATION & MAINTENANCE INSTRUCTIONS

UK
CA | CE



ORIGINAL INSTRUCTIONS

GC06/24

INTRODUCTION

Thank you for purchasing this CLARKE Booster Pump which is suitable for a variety of applications involving the transfer of clean, cold water for domestic and gardening applications.

Please read this manual thoroughly and ensure you are familiar with all aspects relating to your particular pump before its connection and use. This will ensure the safe and proper installation of the pump and assist it in providing a long, trouble free performance.

Please keep these instructions in a safe place for future reference.

GUARANTEE

This product is guaranteed against faulty manufacture for a period of 12 months from the date of purchase. Please keep your receipt which will be required as proof of purchase.

This guarantee is invalid if the product is found to have been abused or tampered with in any way, or not used for the purpose for which it was intended.

Faulty goods should be returned to their place of purchase, no product can be returned to us without prior permission.

This guarantee does not effect your statutory rights.

ENVIRONMENTAL RECYCLING POLICY



Through purchase of this product, the customer is taking on the obligation to deal with the WEEE in accordance with the WEEE regulations in relation to the treatment, recycling & recovery and environmentally sound disposal of the WEEE.

In effect, this means that this product must not be disposed of with general household waste. It must be disposed of according to the laws governing Waste Electrical and Electronic Equipment (WEEE) at a recognised disposal facility.





If disposing of this product or any damaged components, do not dispose of with general waste. This product contains valuable raw materials. Metal products should be taken to your local civic amenity site for recycling of metal products.

SPECIFICATION

Model	MSP490	MSP590	MSP690
Maximum Delivery	90 L/min	90 L/min	90 L/min
Maximum Head	43 metres	53 metres	64 metres
Maximum water temperature	65 degC	65 degC	65 degC
Operating Pressure	4.3 Bar	5.3 Bar	6.4 Bar
Ingress Protection Rating	IPx5	IPx5	IPx5
Supply	230V~ 50Hz	230V~ 50Hz	230V~ 50Hz
Rated Input Power	1100 W	1350 W	1650 W
Rated Output Power	850 W	1050 W	1300 W
Input current @ Maximum Head	3.06 A	3.73 A	4.38 A
Input current @ Maximum Flow	4.61 A	5.70 A	6.82 A
Inlet/Outlet Thread Size	1" BSP	1" BSP	1" BSP
Product weight	11.8 kg	13.1 kg	14.8 kg
Overall dimensions (L x W x H) mm	406x140x192	431x140x192	485x140x192

SAFETY SYMBOLS

The following symbols may be displayed on the machine or its packaging.

	Read this instruction booklet carefully before use.		Wear ear defenders
	Wear eye protection		Recycle unwanted materials under WEEE Directive
	Wear protective gloves		General Hazard

GENERAL SAFETY PRECAUTIONS

Before using this product it is in your own interest to read and pay attention to the following safety rules.



WARNING: ALWAYS CONNECT THE PUMP TO AN EARTHED POWER SUPPLY VIA AN RCD.

1. **ALWAYS** keep the working area clean and well lit. Floors should always be kept clear. Cluttered or dark areas invite accidents.
 2. **NEVER** over-reach. Keep your proper footing and balance at all times when installing or maintaining the pump.
 3. **NEVER** direct any water discharge towards electrical wiring or equipment.
 4. **ALWAYS** thoroughly familiarise yourself with this pump & its operation, and follow all instructions in this manual. **NEVER** allow persons unfamiliar with these instructions to install or operate the pump.
 5. **ALWAYS** ensure that the pump is properly installed to prevent it from moving during operation and that the immediate area surrounding the pump is kept clear.
 6. **ALWAYS** maintain the pump with care and keep it clean for best / safest performance.
 7. **NEVER** modify this pump in any way. Use it only for the purpose for which it is designed.
 8. **NEVER** use for pumping flammable liquids or corrosive chemicals. This pump is only designed to pump clean water.
 9. **ALWAYS** have the pump serviced by your local dealer, using only identical replacement parts. This will ensure the safety of the pump is maintained. The use of non standard parts could be hazardous.
 10. **NEVER** use this product if any part is damaged. Have it inspected and repaired by your local CLARKE dealer. **ALWAYS** turn the pump off before carrying out any maintenance.
 11. **NEVER** allow the pump to run dry.
-



CAUTION: THIS PUMP IS NOT A SUBMERSIBLE PUMP. ON NO ACCOUNT SHOULD IT EVER BE IMMERSSED IN WATER.

ELECTRICAL INSTALLATION



WARNING: READ THESE ELECTRICAL SAFETY INSTRUCTIONS THOROUGHLY BEFORE CONNECTING THE PRODUCT TO THE MAINS SUPPLY.

Connect the mains lead to a standard, 230 Volt (50Hz) electrical supply through an approved 13 amp BS 1363 plug or a suitably fused isolator switch.

This product may be fitted with a non-rewireable plug. If it is necessary to change the fuse in the plug, the fuse cover must be refitted. If the fuse cover becomes lost or damaged, the plug must not be used until a suitable replacement is obtained.

If the plug has to be changed because it is not suitable for your socket, or because of damage, it must be removed and a replacement fitted, following the wiring instructions shown below. The old plug must be discarded safely, as insertion into a power socket could cause an electrical hazard.



**WARNING: THE WIRES IN THE POWER CABLE OF THIS PRODUCT ARE COLOURED IN ACCORDANCE WITH THE FOLLOWING CODE:
BLUE = NEUTRAL BROWN = LIVE YELLOW AND GREEN = EARTH**

The colours of the wires in the power cable must agree with the markings on the plug.

- Connect the BLUE wire to the terminal marked N.
- Connect the BROWN wire to the terminal marked L.
- Connect the YELLOW AND GREEN wire to the terminal marked E or \perp .

Plug must be BS1363/A approved.

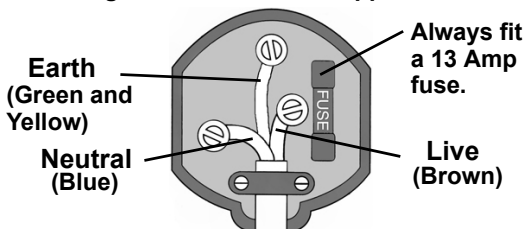

Ensure that the outer sheath of the cable is firmly held by the clamp

AN APPROVED RESIDUAL CURRENT DEVICE (RCD) WHICH HAS A TRIPPING CURRENT OF LESS THAN 30 mA MUST BE USED.

If you are not sure consult a qualified electrician.

INSTALLATION OF THE PUMP

IMPORTANT: The pump MUST NOT be connected to the mains power supply until all hose/pipe installations are completed.

These notes are for guidance on how to achieve a proper working system. If any part of the system is to be connected to the mains water supply, ensure that you comply with your local water authority regulations.

INSTALLATION LAYOUT

The pump must always be installed and operated in a horizontal position using the fixing holes in the base to secure the pump firmly in its operating position. Ensure that there is adequate air circulation around the motor.

Avoid situations where there is the risk of water coming into contact with the outside of the pump. Neither the motor or the terminal box are designed to be waterproof.

The suction lift i.e. the vertical distance between the water level and the pump, should not exceed the distance specified for your pump.

Where the pump is to be a permanent fixture, the fittings to the pump **MUST** be flexible, i.e. a short piece of hose should be inserted between any rigid metal pipework and the pump.

To prevent unnecessary strain or possible distortion to the pump, ensure that adequate support is provided to the hoses and/or pipes. Remember they will be considerably heavier when filled with water.

PIPELINE FITTINGS REQUIRED

Because of the variety of possible installations, no plumbing accessories are supplied. However, accessories designed specifically for this range of pumps are available from your CLARKE dealer.

The performance of your pump will be effected by the diameter of the inlet pipe - any restriction will greatly reduce the flow. We recommend that you use a diameter which is as large as practicable with a suitable reducer for connection to the 1" BSP inlet adapter. The discharge hose should be attached to the outlet adapter (not supplied).

A 1" BSP hose adapter will be required for connection to the inlet and outlet port. These are available from your CLARKE dealer.

A gate valve may be installed in-line on the outlet side of the pump which can be set as required to regulate the flow of water. Do not place any such restriction on the suction side of the pump unless it is an isolator valve in a gravity fed system.

PREPARATION FOR USE

PRIMING THE PUMP

When suction lift is used to draw water into the pump it is essential that all connections and hoses are completely air tight or the system will not work.

Although the pump is a 'self priming' type, it is still necessary to completely fill the inlet side of the pump with water before being started for the first time or if the system has been drained for maintenance/repair. This is carried out as follows:-

1. Remove the filler plug on the top of the pump chamber and fill the pump with water until all air is expelled.

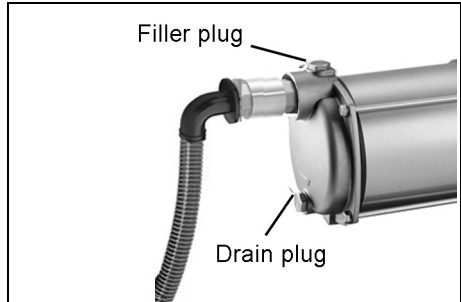

NOTE: If a filter is fitted to your pump it is recommended that you remove the brass plug on top and fill the filter bowl with water.

2. Adjust any valves which may be fitted to the outlet side of the pump so as to ensure as great a flow as possible.
3. Switch on the pump and check for leaks. Water should quickly start to flow through the system. If, depending upon the suction depth, water does not flow, check to ensure:
 - The inlet pipe is secure and free from defects. Even a pin hole could prevent the pump from drawing water efficiently. This is the most common problem encountered when operating water pumps.
 - The pump body has been primed correctly and is completely filled with water.

NOTE: If the pump is gravity or pressure fed, priming will not be necessary as the pressure of water will purge the system of air.

It is essential that all connections and hoses are completely air tight or the system will not work effectively.

The pump should never be operated with any delivery valve completely closed.

TROUBLESHOOTING

Problem	Cause	Solution
Pump does not run.	Thermal protection has been activated.	If the motor has overheated, wait for it to cool down before trying again.
	Faulty power connection	Insert plug securely.
	No mains supply.	Check fused power supply and replace fuse if necessary (check fuse rating). Check circuit breaker.
	Impeller seized/blocked	Disconnect pump from power supply. Investigate cause and clear blockage.
Pump fails to prime	Air leaks through suction hose joints (damaged hose or damaged clamp).	Repair connections/ replace hose as necessary.
	Blocked inlet hose.	Check pipeline for blockage. Check any inlet valve fitted is fully open.
Pump runs but gives poor output	Congested material inside pump	Clean out & backflush pump.
	Suction or delivery line obstructed.	Remove obstruction and ensure there are no kinks in delivery line.
	Inlet pipe leakage.	Check inlet pipe and connector for leaks. Tighten as required.
	Air leaks through damaged seal.	Renew seal.
	Impeller damaged and making poor seal.	Return to your CLARKE dealer for repair.
	Impeller / mechanical seal is badly worn.	Return to your CLARKE dealer for repair.

	High friction losses in the suction line.	Avoid unnecessary curves, restrictions or valves.
	Pump badly sited resulting in suction lift too high.	Set pump as close as possible to the level of the water to be pumped
Sudden loss of flow.	Blockage of inlet pipe.	Check pipeline for blockage.
Undue vibration or noise.	Excessive flow of water.	Decrease flow of water. by adjusting inlet/outlet valves in system.
	Resistance in inlet pipe caused by obstruction.	Check pipe and clean out as necessary
	Loose rotating component.	Return to your dealer for repairs.
	Installation of pump is unstable.	Stop pump and re-position.
	Air pocket in pump or pipeline.	Release plug in impeller housing to release air.
	Damaged impeller.	Return to your CLARKE dealer for repair.

CARE AND MAINTENANCE

Protect the pump and pipework from freezing as the formation of ice may cause serious damage.

The only maintenance required is a regular inspection to ensure that debris is not blocking the passage of water through the pump. Should sediment, chemical or other contaminants come into contact with the pump, flush through with cold clean water as soon as possible.

If you suspect the pump is blocked by debris etc, disconnect it from the power supply and back-flush to clear any blockage using a garden hose.

- You will need to disconnect the outlet hose to do this.

Always keep the pump in a clean condition, checking regularly for loose fastenings or a damaged power cable etc.

The pump should not be taken apart by the user if overhaul is required, but should be taken to your nearest CLARKE dealer for repair.

COMPONENT PARTS

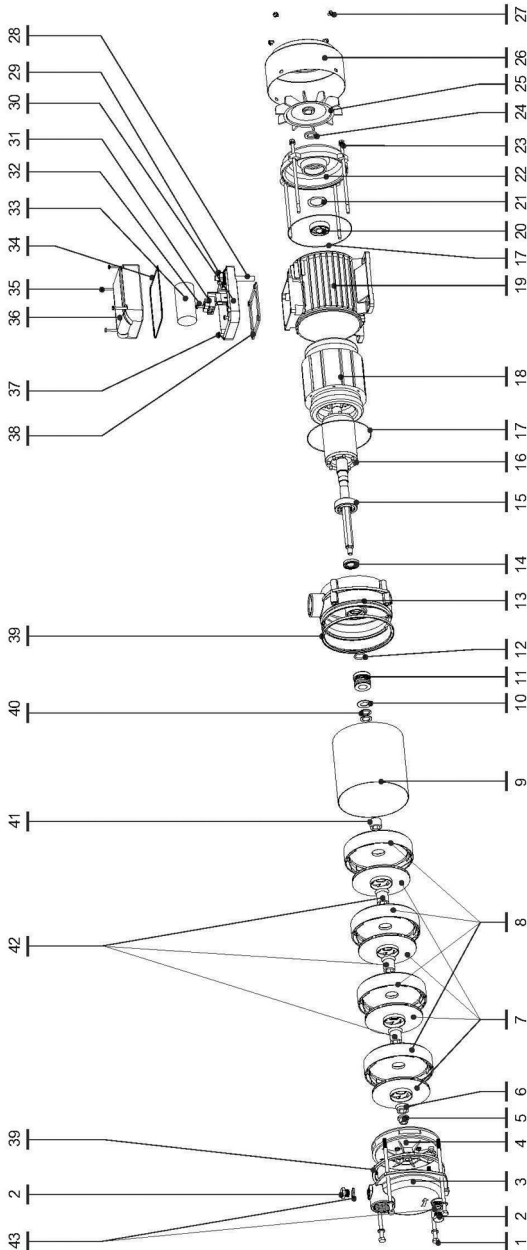

COMPONENT PARTS

ID	DESCRIPTION
1	Tie bolt (1)
2	Screw (1)
3	Suction mounting
4	Self priming cover
5	Locking nut
6	First bushing
7	Impeller
8	Diffuser
9	Pump housing
10	Washer
11	Mechanical seal
12	O-ring (1)
13	Discharge mounting
14	Shaft seal
15	Ball bearing (1)
16	Motor rotor
17	O-ring (2)
18	Stator
19	Motor body
20	Ball bearing (2)
21	Spring washer
22	Motor end cover

ID	DESCRIPTION
23	Tie bolt (2)
24	Seal (1)
25	Fan
26	Fan cover
27	Screw (2)
28	Power cable
29	Terminal box screw
30	Terminal box
31	Terminal block
32	Screw (3)
33	Capacitor
34	Seal (2)
35	Screw (4)
36	Terminal box cover
37	Screw (5)
38	Seal (3)
39	Seal (4)
40	Washer (2)
41	End bushing
42	Centre bushing
43	Seal (5)

DECLARATION OF CONFORMITY - MSP490



DECLARATION OF CONFORMITY

This is an important document and should be retained.

We hereby declare that this product(s) complies with the following legislation:

- 2014/53/EU Electromagnetic Compatibility Directive
- 2006/42/EC Machinery Directive
- 2011/65/EU Restriction of Hazardous Substances (RoHS) Directive

The following standards have been applied to the product(s):

- EN 60335-1:2012+A11+A13+A14+A14-2+A15, EN IEC 60335-2-41:2021+A11, EN ISO 12100:2010, EN 61000-3-3:2013+A1:2019, EN 55014-1:2017+A11:2020, IEC 62321-3-1:2013, IEC 62321-5:2013, EN IEC 61000-3-2:2019, EN 61000-3-2:2014, IEC 62321-7-1:2015, EN 55014-2:2015, IEC 62321-6:2015, IEC 62321-8:2017, EN 62233:2008

The technical documentation required to demonstrate that the product(s) meet(s) the requirement(s) of the aforementioned legislation has been compiled and is available for inspection by the relevant enforcement authorities.

The CE mark was first applied in: 2024

Product Description: Water Pump
Model Number(s): MSP490
Serial/Batch Number: Refer to product/packaging label
Date of Issue: 15/04/2024

Signed:

J.A. Clarke
Director



DECLARATION OF CONFORMITY

This is an important document and should be retained.

We hereby declare that this product(s) complies with the following legislation:

- The Electromagnetic Compatibility Regulations 2016
- The Supply of Machinery (Safety) Regulations 2008
- The Restriction of the Use of Certain Hazardous Substances in Electrical and Electronic Equipment Regulations 2012

The following standards have been applied to the product(s):

- EN 60335-1:2012+A11+A13+A14+A14-2+A15, EN IEC 60335-2-41:2021+A11, EN ISO 12100:2010, EN 61000-3-3:2013+A1:2019, EN 55014-1:2017+A11:2020, IEC 62321-3-1:2013, IEC 62321-5:2013, EN IEC 61000-3-2:2019, EN 61000-3-2:2014, IEC 62321-7-1:2015, EN 55014-2:2015, IEC 62321-6:2015, IEC 62321-8:2017, EN 62233:2008

The technical documentation required to demonstrate that the product(s) meet(s) the requirement(s) of the aforementioned legislation has been compiled and is available for inspection by the relevant enforcement authorities.

The UKCA mark was first applied in: 2024

Product Description: Water Pump
Model Number(s): MSP490
Serial/Batch Number: Refer to product/packaging label
Date of Issue: 15/04/2024

Signed:

J.A. Clarke
Director

DECLARATION OF CONFORMITY - MSP590



DECLARATION OF CONFORMITY

This is an important document and should be retained.

We hereby declare that this product(s) complies with the following legislation:

- 2014/30/EU Electromagnetic Compatibility Directive
- 2006/42/EC Machinery Directive
- 2011/65/EU Restriction of Hazardous Substances (RoHS) Directive

The following standards have been applied to the product(s):

- EN 60335-1:2012+A11+A19+A1+A14+A2+A15, EN IEC 60335-2-41:2021+A11, EN ISO 12100:2010, EN 61000-3-3:2013+A1:2019, EN 55014-1:2017+A11:2020, IEC 62321-3-1:2013, IEC 62321-5:2013, EN IEC 61000-3-2:2019, EN 61000-3-2:2014, IEC 62321-7-1:2015, EN 55014-2:2015, IEC 62321-6:2015, IEC 62321-8:2017, EN 62233:2008

The technical documentation required to demonstrate that the product(s) meet(s) the requirement(s) of the aforementioned legislation has been compiled and is available for inspection by the relevant enforcement authorities.

The CE mark was first applied in: 2024

Product Description: Water Pump
 Model Number(s): MSP590
 Serial/Batch Number: Refer to product/packaging label
 Date of Issue: 15/04/2024

Signed:

J.A. Clarke
Director



DECLARATION OF CONFORMITY

This is an important document and should be retained.

We hereby declare that this product(s) complies with the following legislation:

- The Electromagnetic Compatibility Regulations 2016
- The Supply of Machinery (Safety) Regulations 2008
- The Restriction of the Use of Certain Hazardous Substances in Electrical and Electronic Equipment Regulations 2012

The following standards have been applied to the product(s):

- EN 60335-1:2012+A11+A13+A1+A14+A2+A15, EN IEC 60335-2-41:2021+A11, EN ISO 12100:2010, EN 61000-3-3:2013+A1:2019, EN 55014-1:2017+A11:2020, IEC 62321-3-1:2013, IEC 62321-5:2013, EN IEC 61000-3-2:2019, EN 61000-3-2:2014, IEC 62321-7-1:2015, EN 55014-2:2015, IEC 62321-6:2015, IEC 62321-8:2017, EN 62233:2008

The technical documentation required to demonstrate that the product(s) meet(s) the requirement(s) of the aforementioned legislation has been compiled and is available for inspection by the relevant enforcement authorities.

The UKCA mark was first applied in: 2024

Product Description: Water Pump
 Model Number(s): MSP590
 Serial/Batch Number: Refer to product/packaging label
 Date of Issue: 15/04/2024

Signed:

J.A. Clarke
Director

DECLARATION OF CONFORMITY - MSP690



Fitwilliam Hall, Fitzwilliam Place, Dublin 2

DECLARATION OF CONFORMITY

This is an important document and should be retained.

We hereby declare that this product(s) complies with the following legislation:

- 2014/30/EU *Electromagnetic Compatibility Directive*
- 2006/42/EC *Machinery Directive*
- 2011/65/EU *Restriction of Hazardous Substances (RoHS) Directive*

The following standards have been applied to the product(s):

- EN 60335-1:2012+A13+A14+A14+A2+A15, EN IEC 60335-2-41:2021+A11, EN ISO 12100:2010, EN 61000-3-3:2013+A1:2019, EN 55014-1:2017+A11:2020, IEC 62321-3-1:2013, IEC 62321-5:2013, EN IEC 61000-3-2:2019, EN 61000-3-2:2014, IEC 62321-7-1:2015, EN 55014-2:2015, IEC 62321-6:2015, IEC 62321-8:2017, EN 62233:2008

The technical documentation required to demonstrate that the product(s) meet(s) the requirement(s) of the aforementioned legislation has been compiled and is available for inspection by the relevant enforcement authorities.

The CE mark was first applied in: 2024

Product Description: Water Pump
 Model Number(s): MSP690
 Serial/Batch Number: Refer to product/packaging label
 Date of Issue: 15/04/2024

Signed:

J.A. Clarke
Director



Hemmill Street, Epping, Essex, CM16 4LG

DECLARATION OF CONFORMITY

This is an important document and should be retained.

We hereby declare that this product(s) complies with the following legislation:

- The Electromagnetic Compatibility / Regulations 2016*
- The Supply of Machinery (Safety) Regulations 2008*
- The Restriction of the Use of Certain Hazardous Substances in Electrical and Electronic Equipment Regulations 2012*

The following standards have been applied to the product(s):

- EN 60335-1:2012+A11+A13+A14+A2+A15, EN IEC 60335-2-41:2021+A11, EN ISO 12100:2010, EN 61000-3-3:2013+A1:2019, EN 55014-1:2017+A11:2020, IEC 62321-3-1:2013, IEC 62321-5:2013, EN IEC 61000-3-2:2019, EN 61000-3-2:2014, IEC 62321-7-1:2015, EN 55014-2:2015, IEC 62321-6:2015, IEC 62321-8:2017, EN 62233:2008

The technical documentation required to demonstrate that the product(s) meet(s) the requirement(s) of the aforementioned legislation has been compiled and is available for inspection by the relevant enforcement authorities.

The UKCA mark was first applied in: 2024

Product Description: Water Pump
 Model Number(s): MSP690
 Serial/Batch Number: Refer to product/packaging label
 Date of Issue: 15/04/2024

Signed:

J.A. Clarke
Director

PUMP ACCESSORIES FROM THE CLARKE RANGE



Reinforced suction/delivery hose



Plastic Foot valve filters

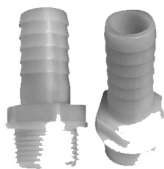

Water pump couplings

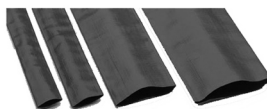

Hose clips

Layflat delivery hose



Electronic control unit



In-line water filter



Hose adaptors (90 deg bend)

A SELECTION FROM THE VAST RANGE OF

Clarke®

QUALITY PRODUCTS



AIR COMPRESSORS

From DIY to industrial, Plus air tools, spray guns and accessories.

GENERATORS

Prime duty or emergency standby for business, home and leisure.

POWER WASHERS

Hot and cold, electric and engine driven - we have what you need

WELDERS

Mig, Arc, Tig and Spot. From DIY to auto/industrial.

METALWORKING

Drills, grinders and saws for DIY and professional use.

WOODWORKING

Saws, sanders, lathes, mortisers and dust extraction.

HYDRAULICS

Cranes, body repair kits, transmission jacks for all types of workshop use.

WATER PUMPS

Submersible, electric and engine driven for DIY, agriculture and industry.

POWER TOOLS

Angle grinders, cordless drill sets, saws and sanders.

STARTERS/CHARGERS

All sizes for car and commercial use.



PARTS & SERVICE:

0208 988 7400

Parts Enquiries

Parts@clarkeinternational.com

Servicing & Technical Enquiries

Service@clarkeinternational.com

SALES: UK 01992 565333 or Export 00 44 (0)1992 565335

Clarke INTERNATIONAL Hemnall Street, Epping, Essex CM16 4LG
www.clarkeinternational.com